

# PRESTRESSED CONCRETE RAILWAY SLEEPERS



THE INDIAN HUME PIPE CO. LTD.

# THE ADVANTAGES OF IHP PRETENSIONED MONOBLOCK

1

## ADVANTAGES OVER TIMBER SLEEPERS

### DURABILITY

The life of IHP sleeper in track is estimated at not less than 50 years. This exceeds that of any type of timber sleeper, even in the most favourable of climates. In certain areas of the world extremes in temperature, humidity, fungoid or insect attack, not to mention timber quality, reduces sleeper life to as little as 15 years.

### ECONOMY

In some countries of the world the economy of initial supply is now with the concrete sleeper. As suitable timber becomes scarcer and increased production requirements reduce the price of the concrete sleeper the comparison will become even more favourable to the concrete sleeper. In countries where the initial costs are reversed, consideration must be given in any economic appraisal to the durability, maintenance and design aspects.

### LOW MAINTENANCE COSTS

Maintenance costs associated with concrete sleepers can show a significant saving over maintenance costs for timber sleepers, dependent on the labour and material cost situation. The built-in nature of the fastening avoids the frequent attention which has to be given to the normal base-plate fastened to the timber sleeper.

### STABILITY

The heavier IHP sleeper produces a higher resistance to lateral movement and also reduces the vertical movement under traffic of

imperfectly packed sleepers; important factors in relation to continuous welded rail. In conditions of excessive heat, a concrete sleepered track is less prone to vertical and horizontal distortions, and this has important safety as well as maintenance implications.

### MAINTENANCE OF GAUGE

Due to the rigidity of the cast-in portion of the rail fitting, a concrete sleeper maintains the rail gauge much better than the timber sleeper, where the increase of gauge over the years is an accepted phenomenon. This applies especially to curved track.

2

## ADVANTAGES OVER POST TENSIONED MONOLITHIC TYPES

### ECONOMY THROUGH STRENGTH

The use of many fully bonded tendons allows for the provision of a larger prestressing force, with better stress distribution, within a given area of concrete.

Consequently it is possible to produce sleepers with a greater moment of resistance than for the post-tensioned types. This has the subsequential effect to allowing a greater spacing (70 centimeters) between the sleepers than is advisable with the post-tensioned monolithic or two block types.

### ECONOMY IN STEEL

Drawn high tensile steel only is required in the IHP sleeper. In post-tensioned designs the steel tendons involve purpose fabrication, and end anchorages are required. In some types special alloy steels are

used, and these are not always easily obtainable.

The tendons employed on the longline IHP process are common to the prestressed concrete industry of the world, and in consequence are readily obtainable.

### NO GROUTING

The IHP pre-tensioned system employs fully bonded tendons. The separate and unsatisfactory operation of grouting the tendons after stressing is thus completely eliminated.

### STRESSING

The long-line process of manufacture dictates that large extensions of the tendons are required at stressing. Any error or inaccuracy in measuring this extension has, therefore, only a minimal effect on the final prestressing force in the sleeper. With post-tensioned types the tendons are short and any small error can have a profound and disastrous effect on the final stress in the sleeper.

This statement leads to two conclusions :-

- (a) The IHP process produces a more uniform and accurate sleeper.
- (b) The high-quality sleeper produced by the IHP system is the result of well proven production techniques rather than the individual skills of the personnel involved in the manufacturing process.

It is sometimes claimed as an advantage that the post-tensioned concrete sleeper can be made shorter than the pretensioned sleeper because of the need to develop full bond in the latter. However some railways are lengthening their post tensioned sleepers because the additional length provides



# SLEEPERS

better ballast support to the track.

## **SLEEPER QUALITY**

Every pretensioned sleeper is proven on transfer of stress; concrete and wire are immediately and obviously in balance any failures are detected at this stage and not in the track.

## **NO STOCK PILES**

IHP sleepers can be taken straight from the production lines and loaded directly for delivery. The post-tensioned designs require a large stock piling area prior to despatch.

## **PRODUCTION**

The production operations are simple and do not require a sophisticated labour force as with the more complicated methods employed by the post-tensioned sleeper manufacturers.

3

## **ADVANTAGES OVER TWO BLOCK SLEEPERS**

### **STABILITY**

The resistance to longitudinal and transverse movement is mainly dependent on four criteria :-

- (a) Dead weight of sleeper..
- (b) Uniformity and holding characteristics of rail to sleeper fitting.
- (c) Balast consolidation around sleeper.
- (d) Friction area between sleeper and ballast.

These are discussed below :-

### **DEAD WEIGHT**

Compared with the well known two block sleeper, the dead weight per unit length is in favour of the IHP sleeper in the ratio of 1.25 to 1. Resistance to differential longitudinal movement of rail to rail (i.e. one rail

moving ahead of the other) is in favour of the IHP sleeper in the ratio of 2 to 1.

### **RAIL FASTENING**

The spring-clip fastening holds the rail firmly yet resiliently, and with uniform toe-load, automatically on installation. The fastening used with two block sleepers is capable of producing similar holding loads, but is wholly dependent on the continued efficiency of a bolted fastening in an exacting vibration situation.

### **LONGITUDINAL BALLAST RESISTANCE**

The projected transverse area of the IHP sleeper, compared with the two block sleeper, is greater in the ratio of 1.6 to-1.

### **BASE FRICTION**

The surface area of the base of sleepers in continuous and assured contact with the ballast creates frictional resistance to lateral movement. This area per unit length is in favour of the IHP sleeper in the ratio of 1.5 to 1.

### **MAINTENANCE OF GAUGE**

The rigidity of the monolithic sleeper ensures the rails are located constantly at the correct gauge and are maintained in the correct relative inclination. For example, it is impossible for one end of the sleeper to rotate relative to the other end. These advantages become apparent during aligning and levelling operations.

### **EASE OF MAINTENANCE**

Maintenance of cross level is more difficult with the two block type of sleeper, since twist is a weakness of the design which is hard to eliminate in the track.

### **DURABILITY**

The steel tie bars used with the two block sleeper are subject to corrosion and attack from atmospheric conditions. The tie bars are particularly vulnerable on account of their relative slenderness.

Spalling of the concrete blocks at the point of entry of the metal tie bars is inevitable and progressive. The high quality concrete used in the IHP sleeper is more resistant to the effects of abrasion than that of the unstressed concrete in the two block type.

### **RESISTANCE TO DERAILMENT**

In cases of derailment the tie bars of the two block sleepers are inevitably deformed, with consequential loss of track gauge and certain derailment of all following wheels.

### **ELIMINATION OF CRACKING**

If, due to abnormal overload conditions, cracks appear in the prestressed concrete monolithic sleepers, these will automatically reclose upon return to normal loads. This is not the case with the unstressed concrete of the two block type. The cracks remain open for corrosive attacks upon the internal steel reinforcement.

### **SIGNALLING**

Route signalling depends upon the reliability of track circuiting, which is achieved by the inclusion of insulation pieces of the rail fastening. In the case of the IHP sleeper a failure of these insulation pieces at each end of a single sleeper will have little noticeable effect on the overall insulation properties of a given length of track. However, the same is not true with the two block sleeper, as the rail fastening is in direct contact with the steel tie bar. A complete short circuit is effected should the insulator at both ends of a single sleeper fail. The consequences of such a failure are extremely serious, and, when using continuously welded track, the location of the faulty sleeper is a major operation, as only one sleeper may be defective in many thousands.

# IHP MONOBLOCK SLEEPER

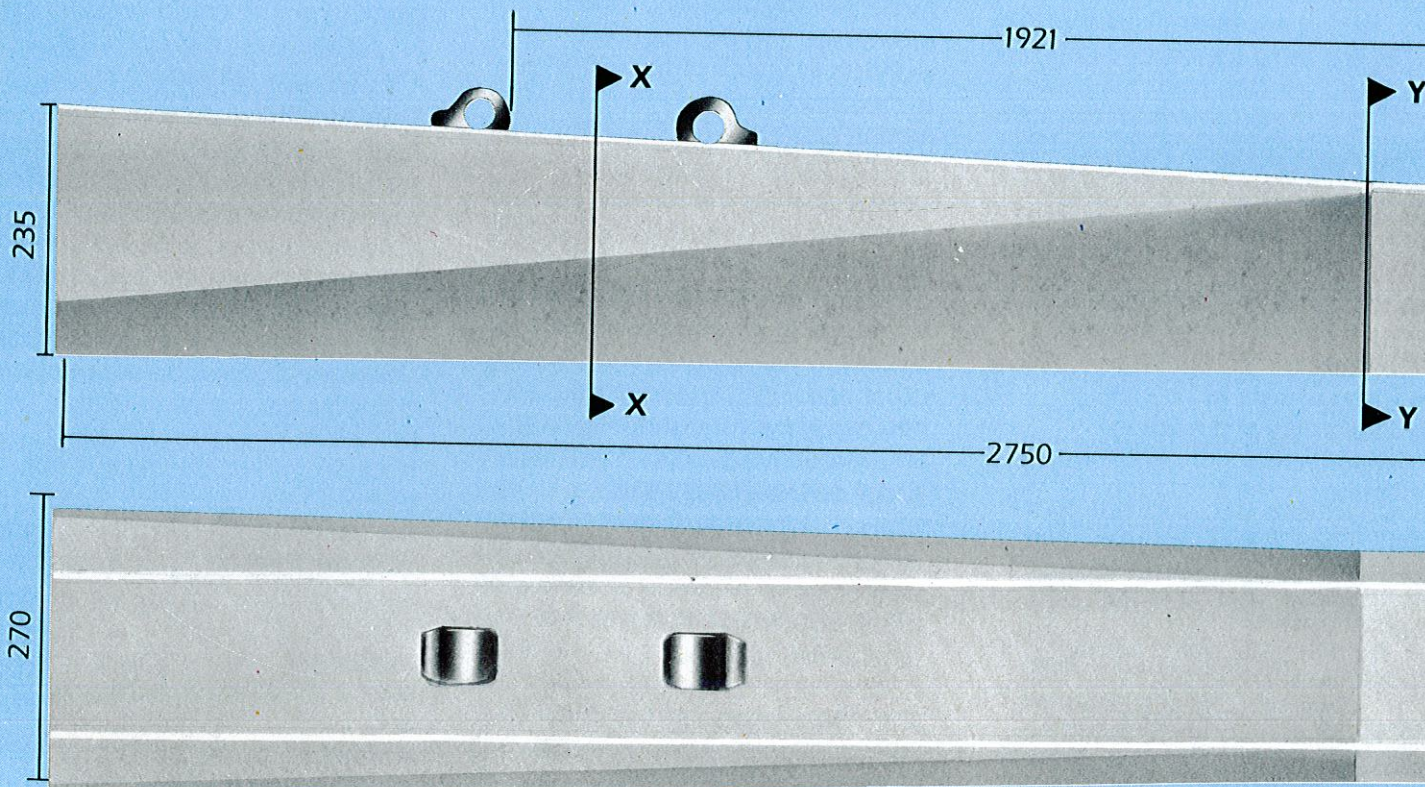

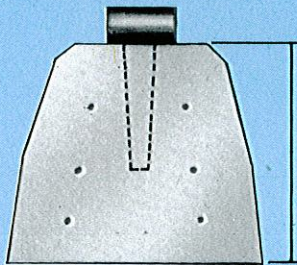
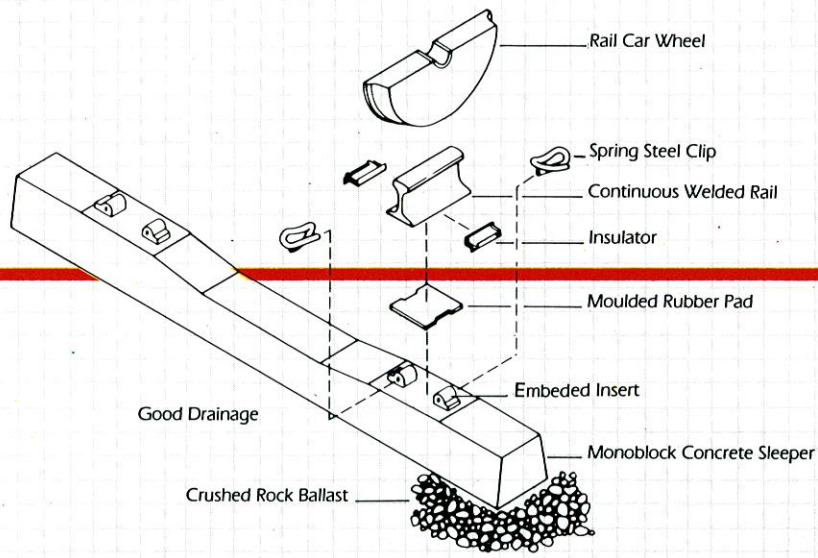

SECTION AT X-X

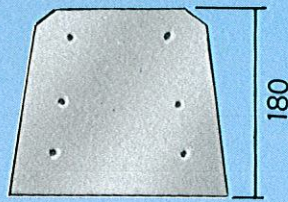

SECTION AT Y-Y

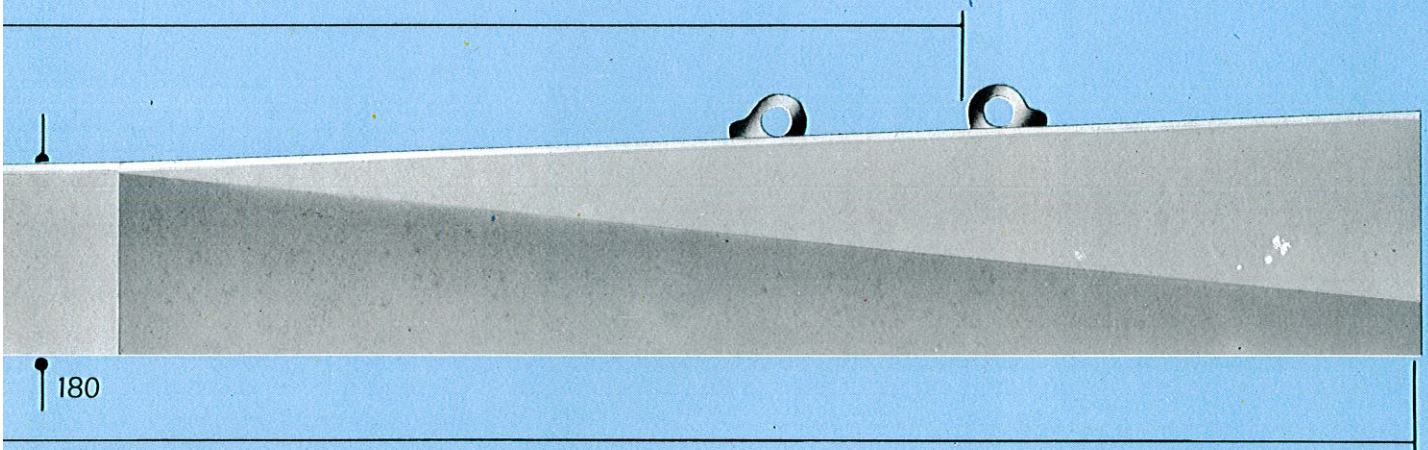

180

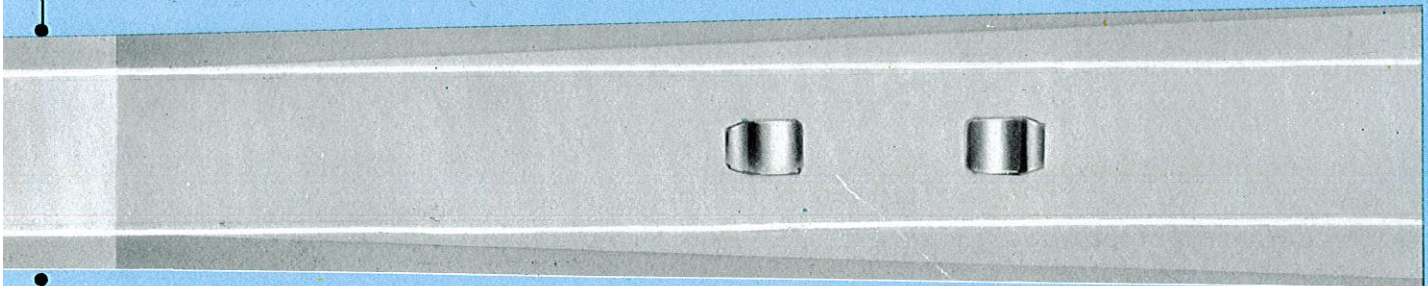

220

# MANUFACTURING PROCESS

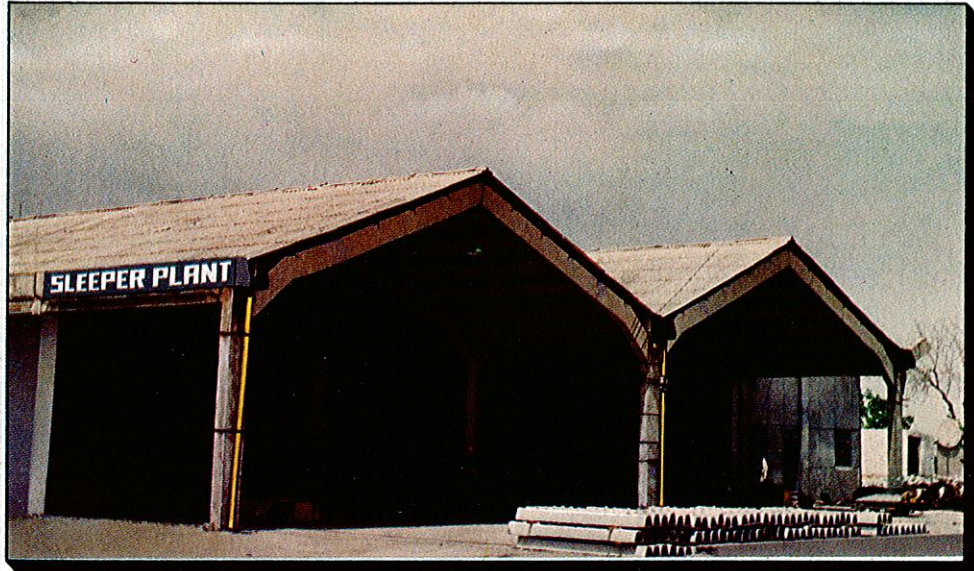

The process of manufacturing IHP Prestressed Concrete Railway Sleepers consists, broadly speaking, of the following steps:

- 1 Tensioning
- 2 Concreting
- 3 Demoulding
- 4 Control Testing

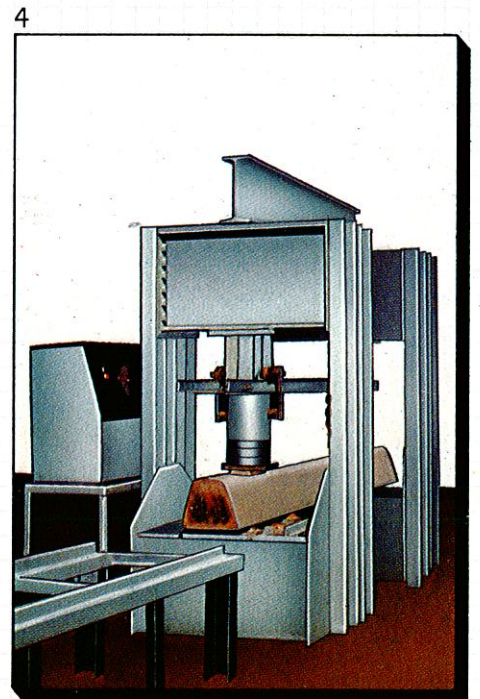
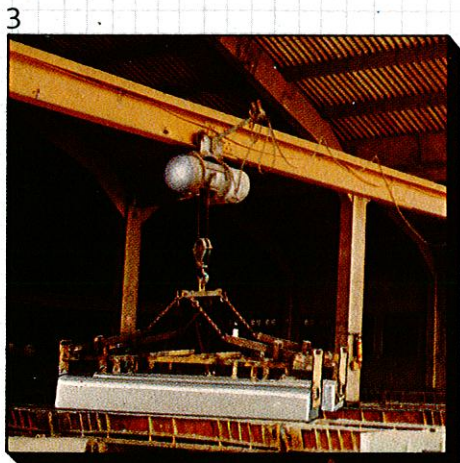
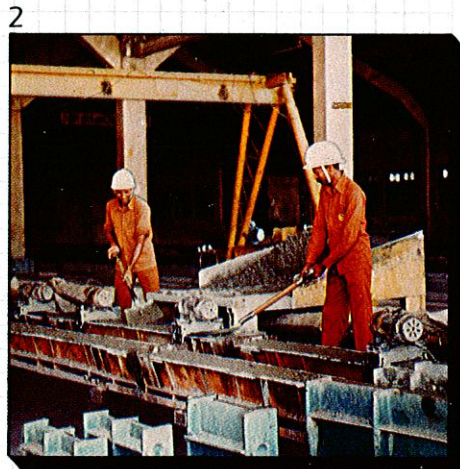
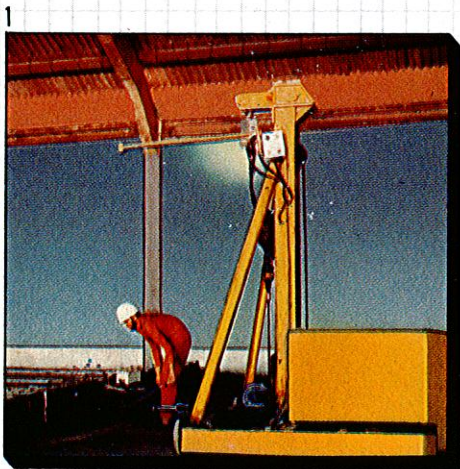



Abu Ghraib plant



The Indian Hume Pipe Company Limited (IHP) established in 1926, is a pioneer in Precast Concrete Industry in India.

It introduced Reinforced Concrete Pipes in 1926, R.C.C. Poles in 1940, P.S.C. Poles in 1960, Prestressed Concrete Pipes in 1956 and Sleepers in 1970.

Prestressed Concrete Sleepers are made by the Company by long line system in technical association with Dow Mac Concrete Ltd., of England, the world leaders in sleepers. Over 8.5 lakh sleepers made by the Company are in the prestigious routes of Indian Railways.

The Company successfully completed a contract for operating Sleeper Plant of Indian Railway Construction Co. at Samawa in 1983. Operated one of the biggest Sleeper Plant at Abu Ghraib - Iraq and produced over 10 lakh sleepers in 1984-85.

Abu Ghraib plant in operation

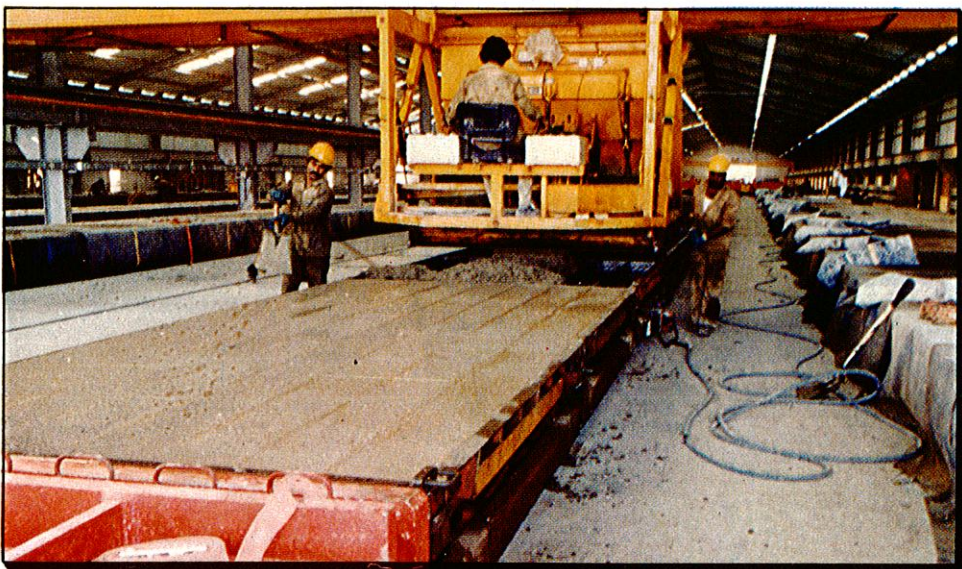

Single track

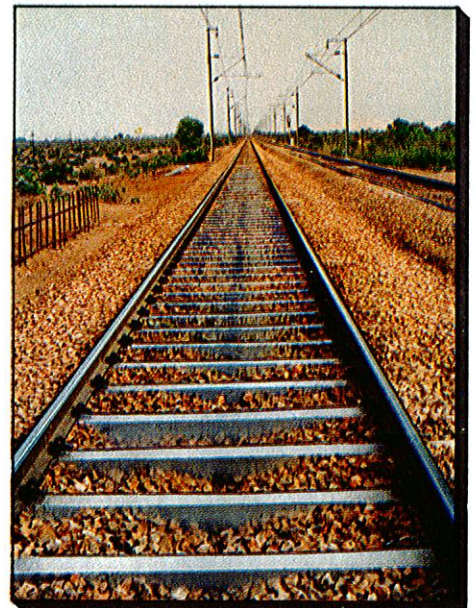



## IHP'S SERVICES

Wherever the project, and whatever the size, IHP will be pleased to co-operate and participate.

Any or all these services can be provided:

- Sleeper Design, Factory Design.
- Construction of Factory.
- Modifications in Factory.
- Supply of Plant.
- Training of Engineers & Operator
- Complete Operation of Factory.
- Management of Factory.
- Setting up Quality Control Procedure.

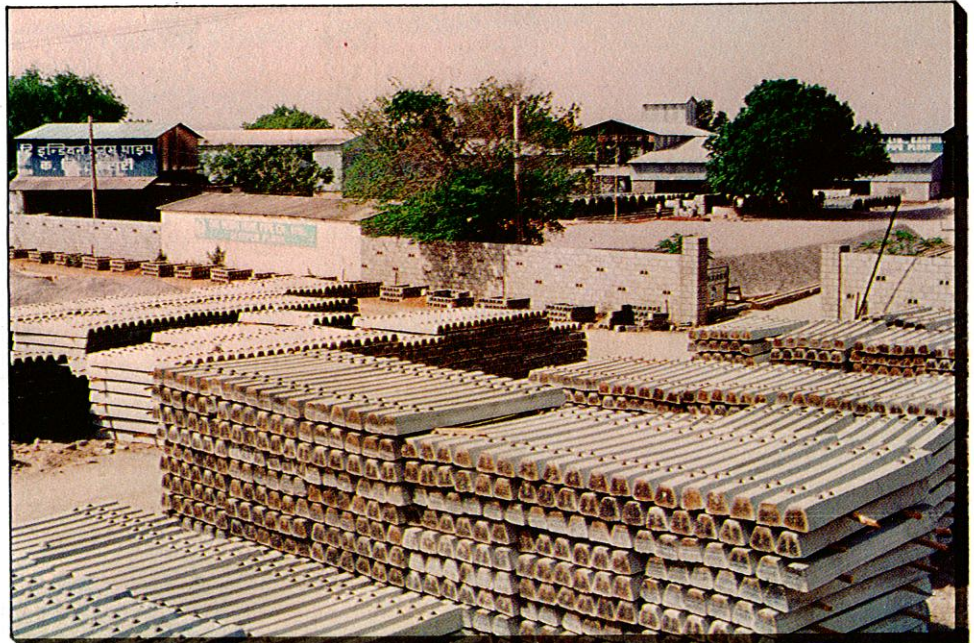

Sleeper Stack



Sleeper Loading



For further information please contact our local office or write to:

**THE INDIAN HUME PIPE CO. LTD.**

Construction House, Walchand Hirachand Marg, Bombay-400 038  
A Walchand Group Industry.